



IR24-P

Presence detector

Presence detector for automatic room control.

- 24 V AC/DC supply voltage
- Potential-free, change-over relay
- Individually settable ON- and OFF-delays

IR24-P is a presence detector designed for automatic ventilation control of HVAC systems. It uses infrared light. The detector has a potential-free change-over relay for activation/deactivation of for instance a fan-coil controller. It saves money and gives higher comfort in premises requiring forced ventilation for shorter periods of time, such as conference rooms, assembly-halls etc. The unit can be wall or corner mounted with a 110°, 15m detection range.

Range adjustment

In order to suit different rooms or areas, the detection range of IR24-P can be adjusted by changing the direction of the sensor. To change the sensor direction, release the screw on the mounting bracket and then carefully move the sensor to the direction desired.

Detection pattern

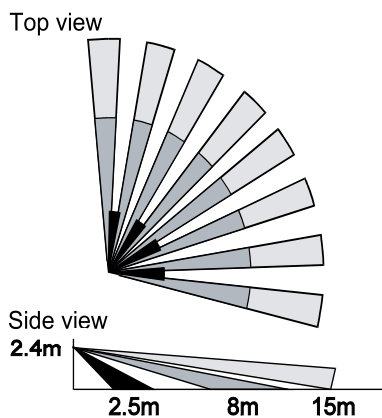

- For wall or ceiling mounting
- Unobtrusive design

ON/OFF-delays

IR24-P has individually settable ON- and OFF-delays. The delays are designed to provide better energy management of HVAC systems.

The ON-delay is the time given to the sensor to certify the occupancy before it activates the fan-coil controller. The OFF-delay is the operating time for the fan-coil after the last detection.

The ON- and OFF-delays are set by placing the jumper head on the corresponding pins according to the table and figure below.

	A	B	C	D	E	F
ON	0 sec.	10 sec.	30 sec.	1 min.	5 min.	10 min.
OFF	10 sec.	1 min.	5 min.	10 min.	20 min.	30 min.

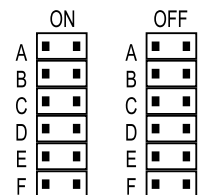

Operation

A: Standby

After the warm-up time expires, the sensor enters into standby mode. The detector will check whether both delays are set. If not, the green LED will blink to indicate.

B: Relay ON-delay

Relay ON-delay is the time given the sensor to verify true occupancy before activating the relay output. Any further detection during ON-delay will NOT reset the timer.

C: 1-minute waiting

When relay ON-delay expires, the sensor enters into a 1-minute waiting time. If no detection occurs within 1 minute, the sensor will return to standby mode. If any detection occurs, then relay output will be activated and relay OFF-delay will be started.

D: Relay OFF-delay

Relay OFF-delay is the time the relay should be active before switching off. Every new detection will reset the timer.

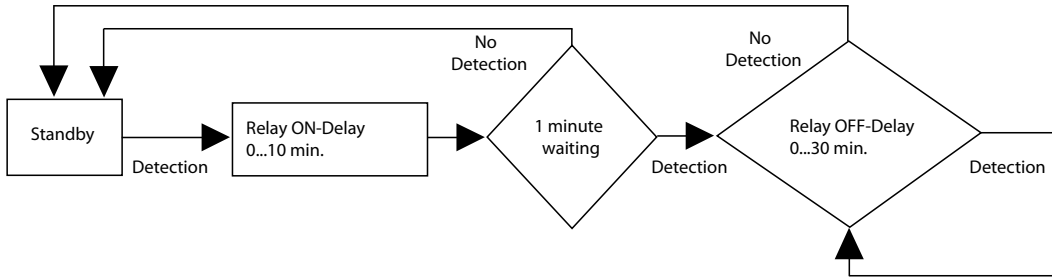

Installation and wiring

N.B.: Do not install the detector where it is exposed to direct sunlight or directly above strong sources of heat. Make sure the detection area does not have any obstruction (plants, large pieces of furniture, curtains etc.) which may block the detection.

1. Mount the base of mounting bracket in the selected position. Lead the cable through the access tunnel of mounting bracket or through the knockout openings.
2. Open the front cover by loosening the locking screw at the bottom. Lead the cable into the unit and assemble the mounting bracket with the unit (see description picture on the right).
3. Connect the cable to the corresponding terminals according to the instructions below.

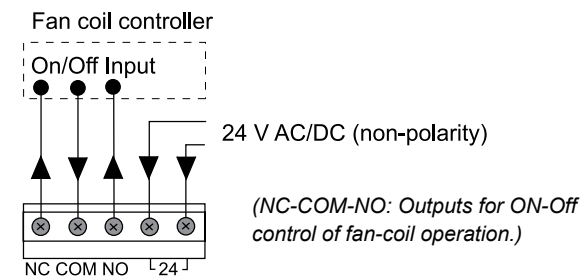
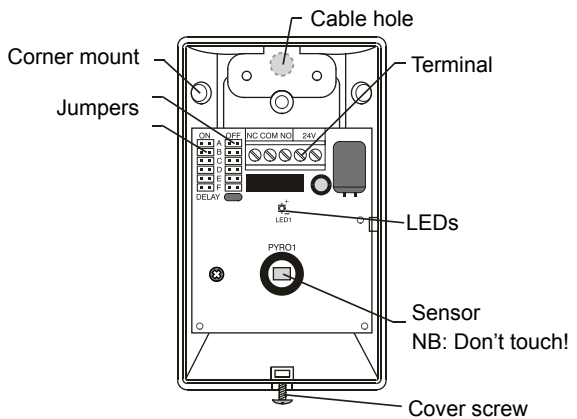

4. Replace the front cover and then proceed with the walking test.
- NB:** Do not touch the infrared sensor in the middle of the electronics cassette.

Walking test

To test the function of the detector, apply power and wait for the detector to warm up (~25 s). The LED will blink (long and short) during the warm-up period. Ensure that the jumper head connectors of the On and OFF-delays are placed in the "A" position (the shortest time). Walk across the detection zone at normal speed. The LED will be lit when the sensor detects the motion.

NB: The LED will blink if a jumper head connector is not properly placed.

Wall mounting

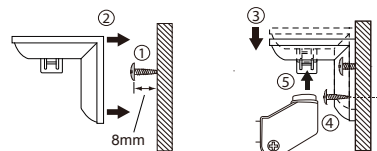

Ceiling mounting

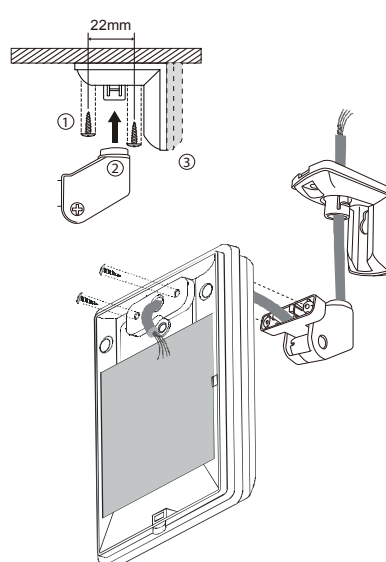

Technical data

Infrared sensor	Dual element
Supply voltage	24 ± 2 V AC/DC
Detection range	15 x 15 m at 110° angle
Power consumption	5 mA @24 V AC
Output	200 mA, 24 V AC/DC, potential-free change-over relay
Ambient humidity	Max. 95% RH
Temperature range	-20...+50°C
Protection class	IP20
Mounting bracket	MB-99
Mounting height	1.8...3.6 m
Detectable speed	0.1...3.0 m/s
ON-delay	0, 10, 30, 60, 300 or 600 s (selectable)
OFF-delay	10, 60, 300, 600, 1200 or 1800 s (selectable)



EMC emissions & immunity standards: This product conforms to the requirements of the EMC Directive 2004/108/EC through product standards EN 61000-6-1 and EN 61000-6-3.
RoHS: This product conforms with the Directive 2011/65/EU of the European Parliament and of the Council.

Dimensions

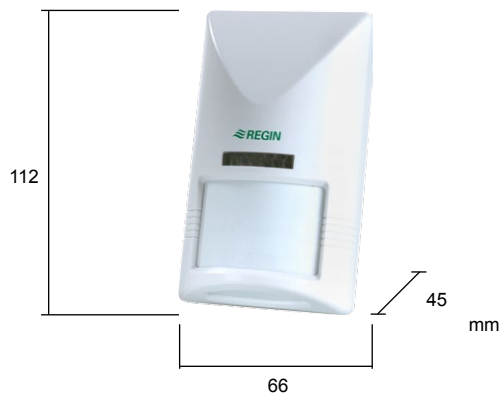

Product documentation

Document	Type
Instruction IR24-P	Instruction for IR24-P

The product documentation is available at www.regin.se.

Head Office Sweden

Phone: +46 31 720 02 00

Web: www.regincontrols.com

Mail: info@regin.se



THE CHALLENGER IN BUILDING AUTOMATION