

KOMFORT EC S(B)(-E) S21/S14

Heat and humidity recovery air handling units

Features

- Air handling units for efficient energy saving supply and exhaust ventilation in flats, houses, cottages and other premises.
- Heat and humidity recovery minimizes ventilation heat losses during cold season and reduces air conditioner load during hot season.
- Controllable air exchange for creating the best suitable indoor microclimate.
- Compatible with round Ø 125, 160 or 200 mm air ducts.



Air flow:
up to 690 m³/h
192 l/s



Heat recovery efficiency:
up to 92 %



Design

- The casing is made of double-skinned polymer-coated steel panels, internally filled with 20, 25, 30, 40 mm (depending on the unit model) mineral wool layer for heat- and sound-insulation.
- The unit is equipped with a hinged service panel to enable convenient access for maintenance or repair operations.
- The spigots are located at the top of the unit and are equipped with rubber seals for airtight connection to the air ducts.

Fans

- The units are equipped with high-efficient EC motors with an external rotor and a centrifugal impeller with backward curved blades.
- EC motors have the best power consumption to air capacity ratio and meet the latest demands concerning energy saving and high-efficient ventilation.
- EC motors are featured with high performance, low noise level and optimum control across the entire speed range.
- The impellers are dynamically balanced.

Air filtration

- The built-in F7 filter provides efficient supply air filtration. The G4 filter is used for extract air cleaning.
- The G3 filters are used for supply and exhaust air filtration in the **KOMFORT EC S(B)200** units.
- Supply air in the **KOMFORT EC S(B)250** units is purified by the G4 and F7 filters. The G4 filter is used for extract air cleaning.

Bypass

- The **KOMFORT EC SB(-E)** units are equipped with a bypass for ventilation (air cooling by the cool air from outside).

HEAT RECOVERY AIR HANDLING UNITS

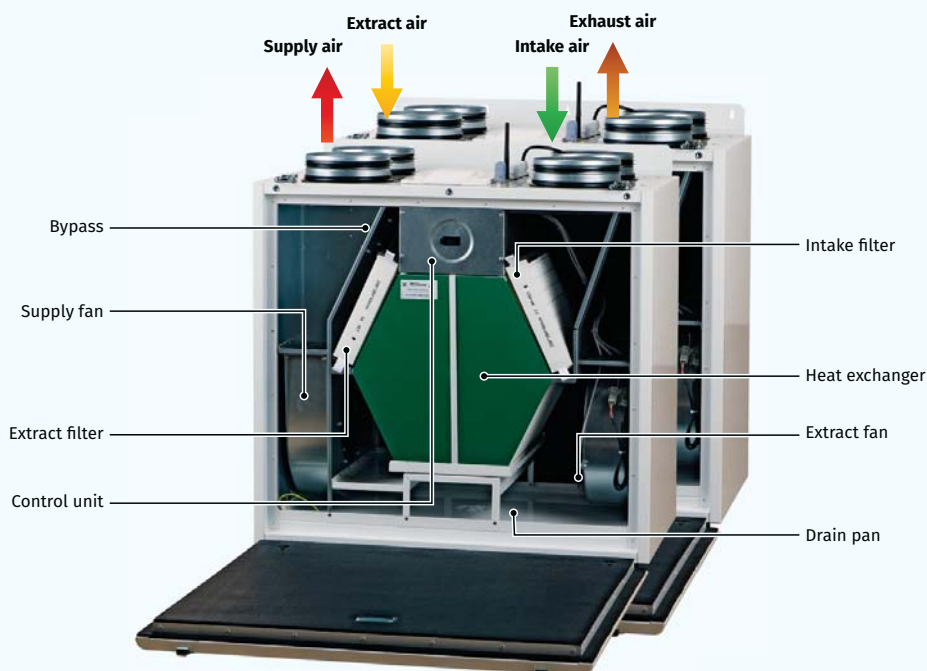

Heat recovery

The **KOMFORT EC S(B)** unit is equipped with a plate counter-flow polystyrene heat exchanger for heat recovery. In the unit condensate is collected and drained to the drain pan under the heat exchanger.



The **KOMFORT EC S(B)-E** unit is equipped with an enthalpy plate counter-flow heat exchanger for energy (heat and humidity) recovery. Due to humidity recovery condensate is not generated in the enthalpy heat exchanger.



- The air flows are completely separated in the heat exchanger. Thus smells and contaminants are not transferred from the extract air to the supply air.
- Heat recovery is based on heat and/or humidity transfer through the heat exchanger plates. In the cold season supply air is heated in the heat exchanger by transferring the heat energy of warm and humid extract air to the cold fresh air. Heat recovery minimizes ventilation heat losses and heating costs respectively.
- In the warm season the heat exchanger performs reverse and intake air is cooled in the heat exchanger by the cool extract air. That reduces operation load on air conditioners and saves electricity.
- When the indoor and outdoor temperature difference is insignificant, heat recovery is not reasonable. In this case the heat exchanger can be temporarily replaced with a summer block for the warm season (available as a specially ordered accessory).

Mounting

- The units are designed for wall or floor mounting.
- Universal casing design provides either left-handed or right-handed unit installation.

Control and automation

- The **KOMFORT EC S(B)(-E) S21** units are equipped with a build-in automation system. The remote control panel is not included in the delivery set (available separately).
- The S21 controller allows integrating the unit into the **Smart Home** system or **BMS (Building Management Systems)**.
- The unit can be controlled by the **Blauberg AHU** mobile application via Wi-Fi.



Download the **Blauberg AHU** app for Android







Download the **Blauberg AHU** app for iOS



- The **KOMFORT EC S(B)(-E) S14** units have an integrated automation system with a wall-mounted control panel S14 with a LED indication.
- The **KOMFORT EC S(B)200** and **KOMFORT EC S250** are available only with an S14 automation.

Automation functions

Functions	KOMFORT EC S(B)(-E) S21	KOMFORT EC S(B)(-E) S14
Unit control via Wi-Fi using a mobile application	+	-
Unit control via a wired remote control panel	S22 panel (option) 	S14 panel 
Unit control via a wireless remote control panel	S22 Wi-Fi panel (option) 	-
Unit control via a wired remote LCD control panel	S25 panel (option) 	-
BMS (Building Management Systems)	RS-485	-
	Wi-Fi	-
	Ethernet	-
	MODBUS (RTU, TCP)	-
Blauberg Cloud Server service	+	-
Speed selection	+	+
Filter replacement indication	according to filter timer according to filter clogging differential pressure switch readings (KOMFORT EC SB550)	according to filter timer -
Alarm indication	full alarm description in the mobile application	LED alarm indication
Week-scheduled operation	+	-
Bypass	automatic	-
	manual	manual
Timers	+	-
Boost mode	+	-
Kamin mode	+	-
Freeze protection	through cyclic stops of the supply fan	through cyclic stops of the supply fan
	through preheating (option)	-
Reheater connection	option	-
Cooler connection	option	-
Minimum supply air temperature control	+	-
Humidity control	option	option
CO ₂ controller	option	option
VOC controller	option	-
PM2.5 control	option	-
Fire alarm sensor connection	option	option

option: function is available when purchasing the appropriate accessory (see the "Accessories" section).

Designation key

Series	Motor type	Spigot modification	Bypass	Nominal air flow, [m ³ /h]	Heat exchanger type	Automation
KOMFORT	EC: electronically commutated motor	S: vertical	_: no bypass	160; 200; 250; 350; 550	_: heat recovery	S21
			B: with a bypass		-E: heat and humidity recovery	S14

Overall dimensions [mm]

Model	Ø D	Ø D1	B	B1	H	H1	L
KOMFORT EC S160(-E) S21/S14	125	18	330	340	665	550	600
KOMFORT EC SB160(-E) S21/S14	125	18	330	340	665	580	600
KOMFORT EC S200(-E) S14	124	18	290	326	858	771	564
KOMFORT EC SB200(-E) S14	124	18	290	326	858	771	564
KOMFORT EC S250(-E) S14	160	18	450	489	881	788	567
KOMFORT EC SB250(-E) S21/S14	160	18	450	489	881	788	567
KOMFORT EC SB350(-E) S21/S14	160	18	583	600	760	675	730
KOMFORT EC SB550(-E) S21/S14	200	18	720	730	760	675	823

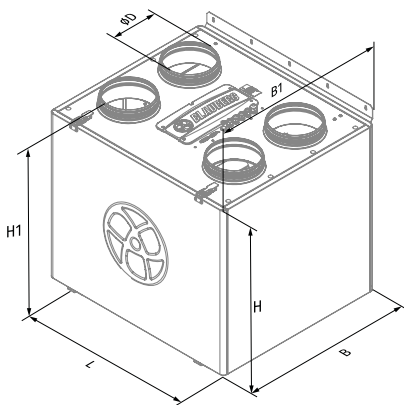

KOMFORT EC S160(-E) S21/S14
 KOMFORT EC SB160(-E) S21/S14
 KOMFORT EC SB350(-E) S21/S14
 KOMFORT EC SB550(-E) S21/S14

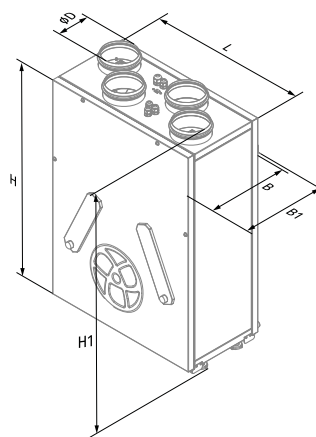

KOMFORT EC S200(-E) S14
 KOMFORT EC SB200(-E) S14

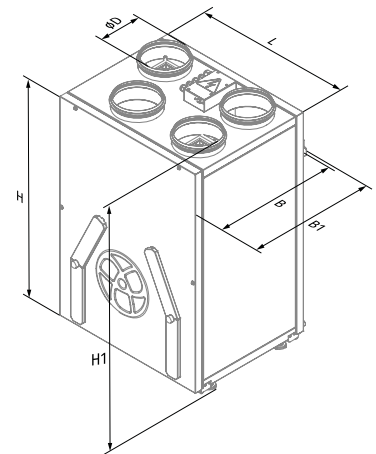

KOMFORT EC S250(-E) S14
 KOMFORT EC SB250(-E) S21/S14

Technical data

Parameters	KOMFORT EC S160 S21 KOMFORT EC S160 S14	KOMFORT EC S160-E S21 KOMFORT EC S160-E S14	KOMFORT EC SB160 S21 KOMFORT EC SB160 S14	KOMFORT EC SB160-E S21 KOMFORT EC SB160-E S14
Supply voltage, 50 (60) Hz [V]	1~ 230	1~ 230	1~ 230	1~ 230
Power [W]	57	57	57	57
Current [A]	0.5	0.5	0.5	0.5
Maximum air flow [m³/h (l/s)]	200 (56)	200 (56)	200 (56)	200 (56)
RPM [min⁻¹]	3770	3770	3770	3770
Sound pressure level at a distance of 3 m [dBA]	24	24	24	24
Transported air temperature [°C]	-25...+40	-25...+40	-25...+40	-25...+40
Casing material	polymer-coated steel	polymer-coated steel	polymer-coated steel	polymer-coated steel
Insulation	20 mm mineral wool	20 mm mineral wool	20 mm mineral wool	20 mm mineral wool
Extract filter	G4	G4	G4	G4
Supply filter	F7 (option: G4)	F7 (option: G4)	F7 (option: G4)	F7 (option: G4)
Connected air duct diameter [mm]	125	125	125	125
Weight [kg]	34	34	36	36
Heat recovery efficiency [%]	85–93	76–92	85–93	76–92
Heat exchanger type	counter-flow	counter-flow	counter-flow	counter-flow
Heat exchanger material	polystyrene	polystyrene	polystyrene	enthalpy
SEC class	A+	A	A+	A
ErP	2016, 2018	2016, 2018	2016, 2018	2016, 2018

KOMFORT EC S(B)160(-E)

Sound power level, A-weighted	Total	Octave frequency band [Hz]								LpA 3 m [dBA]	LpA 1 m [dBA]
		63	125	250	500	1000	2000	4000	8000		
LWA to supply inlet [dBA]	52	28	46	49	41	35	33	36	29		
LWA to supply outlet [dBA]	60	32	52	58	47	37	36	41	35		
LWA to exhaust inlet [dBA]	51	27	45	49	41	36	32	35	29		
LWA to exhaust outlet [dBA]	60	31	50	59	48	36	36	41	32		
LWA to environment [dBA]	45	25	41	42	34	31	28	27	22	24	34

Data provided for point 1 of the air flow diagram

Point	Total power of the unit [W]	Sound pressure level at 3 m (1 m) [dBA]
1	57	24 (34)
2	56	23 (33)
3	54	23 (33)
4	28	20 (30)
5	27	20 (30)
6	26	20 (30)
7	14	13 (23)
8	13	13 (23)
9	13	13 (23)

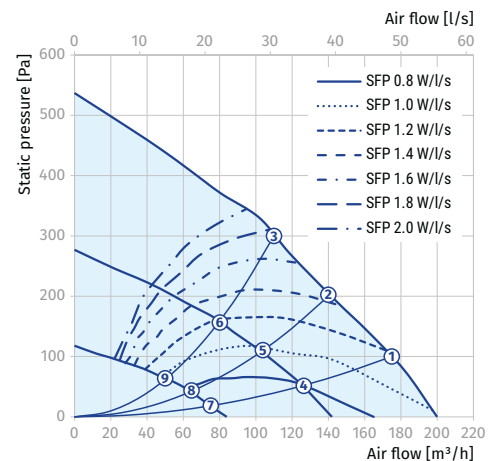

KOMFORT EC S(B)160

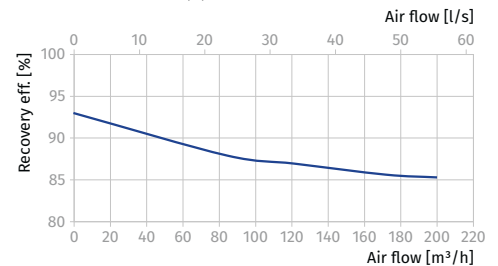

KOMFORT EC S(B)160-E

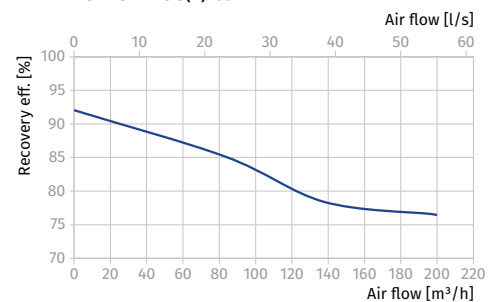

Calculation of air temperature downstream of the heat exchanger:

$$t = t_{\text{outd}} + k_{\text{hr}} \times (t_{\text{extr}} - t_{\text{outd}}) / 100,$$

where

t_{outd} – outdoor air temperature [°C]

t_{extr} – extract air temperature [°C]

k_{hr} – heat exchanger efficiency (according to the diagram) [%]

Parameters	KOMFORT EC S200 S14	KOMFORT EC S200-E S14	KOMFORT EC SB200 S14	KOMFORT EC SB200-E S14
Supply voltage, 50 (60) Hz [V]	1~ 230	1~ 230	1~ 230	1~ 230
Power [W]	112	112	112	112
Current [A]	0.9	0.9	0.9	0.9
Maximum air flow [m³/h (l/s)]	250 (69)	250 (69)	250 (69)	250 (69)
RPM [min ⁻¹]	2050	2050	2050	2050
Sound pressure level at a distance of 3 m [dBA]	24	24	24	24
Transported air temperature [°C]	-25...+40	-25...+40	-25...+40	-25...+40
Casing material	polymer-coated steel	polymer-coated steel	polymer-coated steel	polymer-coated steel
Insulation	25 mm mineral wool	25 mm mineral wool	25 mm mineral wool	25 mm mineral wool
Extract filter	G3	G3	G3	G3
Supply filter	G3	G3	G3	G3
Connected air duct diameter [mm]	125	125	125	125
Weight [kg]	45	45	45	45
Heat recovery efficiency [%]	83–98	74–94	83–98	74–94
Heat exchanger type	counter-flow	counter-flow	counter-flow	counter-flow
Heat exchanger material	polystyrene	enthalpy	polystyrene	enthalpy
SEC class	A+	A	A+	A
ErP	2016, 2018	2016, 2018	2016, 2018	2016, 2018

KOMFORT EC S(B)200 (-E)

Sound power level, A-weighted	Total	Octave frequency band [Hz]								LpA 3 m [dBA]	LpA 1 m [dBA]
		63	125	250	500	1000	2000	4000	8000		
L _{WA} to supply inlet [dBA]	51	28	46	49	41	35	33	36	29		
L _{WA} to supply outlet [dBA]	60	32	52	58	47	37	36	41	35		
L _{WA} to exhaust inlet [dBA]	51	27	44	49	41	35	32	34	29		
L _{WA} to exhaust outlet [dBA]	60	31	50	59	48	36	36	41	32		
L _{WA} to environment [dBA]	44	24	40	41	34	31	27	26	22	24	34

Data provided for point 1 of the air flow diagram

Point	Total power of the unit [W]	Sound pressure level at 3 m (1 m) [dBA]
1	103	24 (34)
2	95	23 (33)
3	88	23 (33)
4	42	19 (29)
5	38	18 (28)
6	36	18 (28)
7	16	12 (22)
8	15	12 (22)
9	15	11 (21)

BRE

Exhaust spigot configuration	Air flow [l/s]	Specific fan power input [W/l/s]	Heat exchange efficiency [%]
Kitchen + 1 additional room with high level of humidity	21	0.67	87
Kitchen + 2 additional rooms with high levels of humidity	29	0.69	85
Kitchen + 3 additional rooms with high levels of humidity	37	0.88	84
Kitchen + 4 additional rooms with high levels of humidity	45	1.13	83
Kitchen + 5 additional rooms with high levels of humidity	53	1.37	83

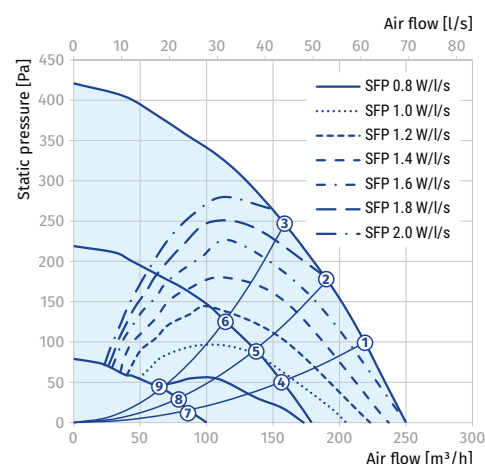

KOMFORT EC S(B)200

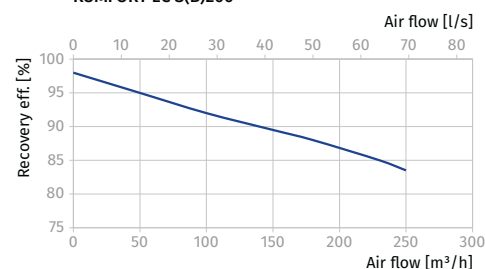

KOMFORT EC S(B)200-E

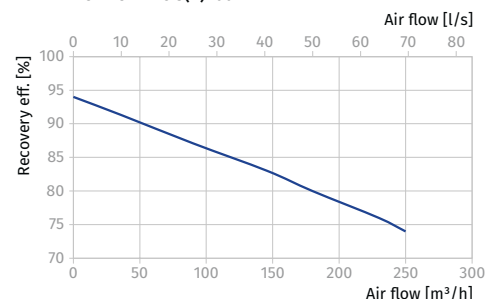

Parameters	KOMFORT EC S250 S14	KOMFORT EC S250-E S14	KOMFORT EC SB250 S21 KOMFORT EC SB250 S14	KOMFORT EC SB250-E S21 KOMFORT EC SB250-E S14
Supply voltage, 50 (60) Hz [V]	1~ 230	1~ 230	1~ 230	1~ 230
Power [W]	115	115	115	115
Current [A]	0.9	0.9	0.9	0.9
Maximum air flow [m³/h (l/s)]	290 (81)	290 (81)	290 (81)	290 (81)
RPM [min ⁻¹]	2050	2050	2050	2050
Sound pressure level at a distance of 3 m [dBA]	25	25	25	25
Transported air temperature [°C]	-25...+40	-25...+40	-25...+40	-25...+40
Casing material	polymer-coated steel	polymer-coated steel	polymer-coated steel	polymer-coated steel
Insulation	30 mm mineral wool	30 mm mineral wool	30 mm mineral wool	30 mm mineral wool
Extract filter	G4	G4	G4	G4
Supply filter	G4+F7	G4+F7	G4+F7	G4+F7
Connected air duct diameter [mm]	160	160	160	160
Weight [kg]	51	51	51	51
Heat recovery efficiency [%]	85–94	78–90	85–94	78–90
Heat exchanger type	counter-flow	counter-flow	counter-flow	counter-flow
Heat exchanger material	polystyrene	enthalpy	polystyrene	enthalpy
SEC class	A+	A	A+	A
ErP	2016, 2018	2016, 2018	2016, 2018	2016, 2018

KOMFORT EC S(B)250 (-E)

Sound power level, A-weighted	Total	Octave frequency band [Hz]								LpA 3 m [dBA]	LpA 1 m [dBA]
		63	125	250	500	1000	2000	4000	8000		
LWA to supply inlet [dBA]	52	28	46	50	41	36	33	36	29		
LWA to supply outlet [dBA]	61	33	53	60	48	38	37	43	36		
LWA to exhaust inlet [dBA]	52	28	46	50	42	36	33	35	30		
LWA to exhaust outlet [dBA]	62	32	51	61	49	37	37	42	33		
LWA to environment [dBA]	45	25	41	42	35	32	28	27	22	25	35

Data provided for point 1 of the air flow diagram

Point	Total power of the unit [W]	Sound pressure level at 3 m (1 m) [dBA]
1	106	25 (35)
2	95	24 (34)
3	82	24 (34)
4	44	20 (30)
5	40	19 (29)
6	36	19 (29)
7	16	13 (23)
8	15	12 (22)
9	15	12 (22)

BRE

Exhaust spigot configuration	Air flow [l/s]	Specific fan power input [W/l/s]	Heat exchange efficiency [%]
Kitchen + 1 additional room with high level of humidity	21	0.65	92
Kitchen + 2 additional rooms with high levels of humidity	29	0.68	91
Kitchen + 3 additional rooms with high levels of humidity	37	0.77	90
Kitchen + 4 additional rooms with high levels of humidity	45	0.94	89
Kitchen + 5 additional rooms with high levels of humidity	53	1.12	88
Kitchen + 6 additional rooms with high levels of humidity	61	1.35	87
Kitchen + 7 additional rooms with high levels of humidity	69	1.70	86

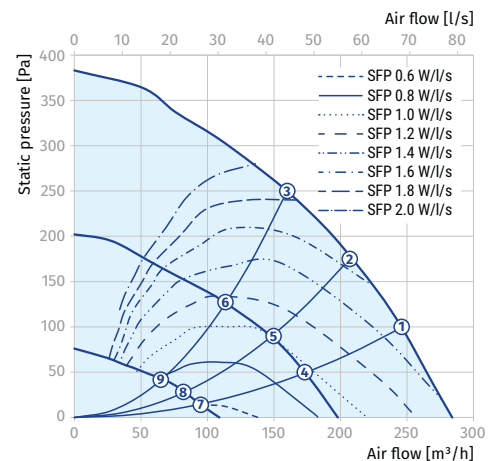

KOMFORT EC S(B)200-E

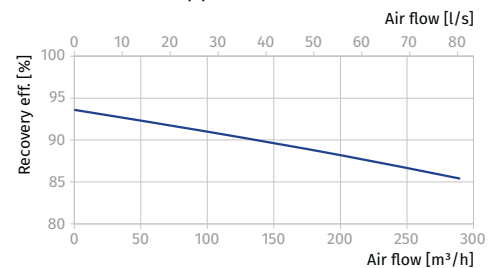

KOMFORT EC S(B)250-E

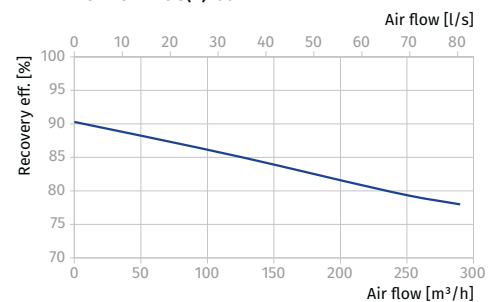

Parameters	KOMFORT EC SB350 S21 KOMFORT EC SB350 S14	KOMFORT EC SB350-E S21 KOMFORT EC SB350-E S14
Supply voltage, 50 (60) Hz [V]	1~ 230	1~ 230
Power [W]	178	178
Current [A]	1.4	1.4
Maximum air flow [m³/h (l/s)]	450 (125)	450 (125)
RPM [min ⁻¹]	3200	3200
Sound pressure level at a distance of 3 m [dBA]	28	28
Transported air temperature [°C]	-25...+40	-25...+40
Casing material	polymer-coated steel	polymer-coated steel
Insulation	40 mm mineral wool	40 mm mineral wool
Extract filter	G4	G4
Supply filter	F7 (option: G4)	F7 (option: G4)
Connected air duct diameter [mm]	160	160
Weight [kg]	64	64
Heat recovery efficiency [%]	85-92	73-91
Heat exchanger type	counter-flow	counter-flow
Heat exchanger material	polystyrene	enthalpy
SEC class	A+	A
ErP	2016, 2018	2016, 2018

KOMFORT EC SB350(-E)

Sound power level, A-weighted	Total	Octave frequency band [Hz]								LpA 3 m [dBA]	LpA 1 m [dBA]
		63	125	250	500	1000	2000	4000	8000		
L _{WA} to supply inlet [dBA]	56	50	46	53	45	39	34	36	32		
L _{WA} to supply outlet [dBA]	64	56	52	63	52	39	38	43	35		
L _{WA} to exhaust inlet [dBA]	56	52	46	53	45	38	34	36	31		
L _{WA} to exhaust outlet [dBA]	64	58	53	62	51	40	38	42	33		
L _{WA} to environment [dBA]	49	45	40	44	38	33	29	27	22	28	38

Data provided for point 1 of the air flow diagram

Point	Total power of the unit [W]	Sound pressure level at 3 m (1 m) [dBA]
1	177	28 (38)
2	175	27 (37)
3	170	27 (37)
4	71	23 (33)
5	71	22 (32)
6	69	22 (32)
7	21	15 (25)
8	21	14 (24)
9	21	14 (24)

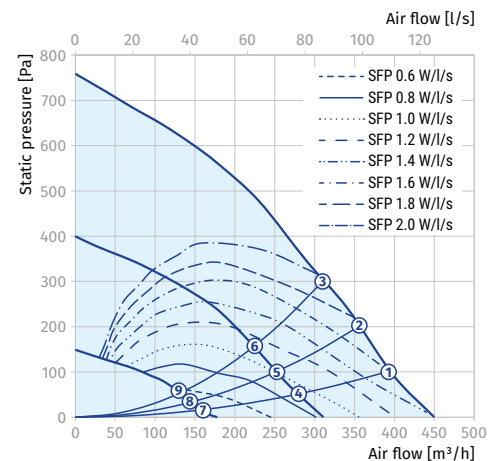

KOMFORT EC SB350

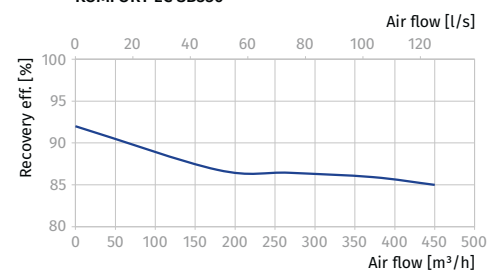

KOMFORT EC SB350-E

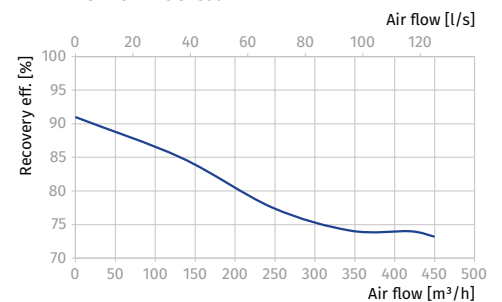

KOMFORT EC SB350

Parameters	KOMFORT EC SB550 S21 KOMFORT EC SB550 S14	KOMFORT EC SB550-E S21 KOMFORT EC SB550-E S14
Supply voltage, 50 (60) Hz [V]	1~ 230	1~ 230
Power [W]	337	337
Current [A]	2.4	2.4
Maximum air flow [m³/h (l/s)]	690 (192)	690 (192)
RPM [min ⁻¹]	2860	2860
Sound pressure level at a distance of 3 m [dBA]	26	26
Transported air temperature [°C]	-25...+40	-25...+40
Casing material	polymer-coated steel	polymer-coated steel
Insulation	40 mm mineral wool	40 mm mineral wool
Extract filter	G4	G4
Supply filter	F7 (option: G4)	F7 (option: G4)
Connected air duct diameter [mm]	200	200
Weight [kg]	82	82
Heat recovery efficiency [%]	84–92	73–91
Heat exchanger type	counter-flow	counter-flow
Heat exchanger material	polystyrene	enthalpy
SEC class	A+	A
ErP	2016, 2018	2016, 2018

KOMFORT EC SB550(-E)

Sound power level, A-weighted	Total	Octave frequency band [Hz]								LpA 3 m [dBA]	LpA 1 m [dBA]
		63	125	250	500	1000	2000	4000	8000		
LWA to supply inlet [dBA]	54	47	42	50	44	41	39	39	31		
LWA to supply outlet [dBA]	69	63	56	65	59	55	50	52	46		
LWA to exhaust inlet [dBA]	54	47	41	51	43	33	31	34	30		
LWA to exhaust outlet [dBA]	65	61	50	61	55	46	43	46	40		
LWA to environment [dBA]	47	42	37	43	36	31	28	26	21	26	36

Data provided for point 1 of the air flow diagram

Point	Total power of the unit [W]	Sound pressure level at 3 m (1 m) [dBA]
1	337	26 (36)
2	337	26 (36)
3	337	25 (35)
4	118	24 (34)
5	113	24 (34)
6	107	22 (32)
7	34	15 (25)
8	66	14 (24)
9	32	13 (23)

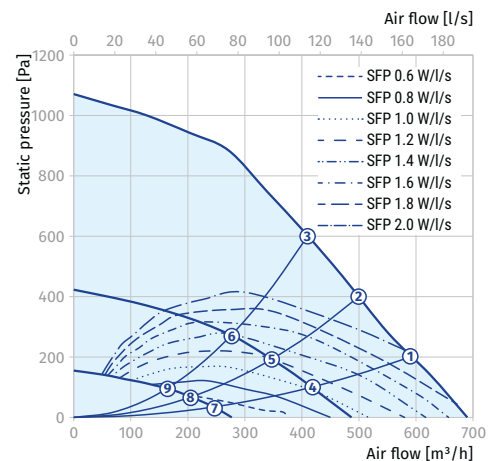



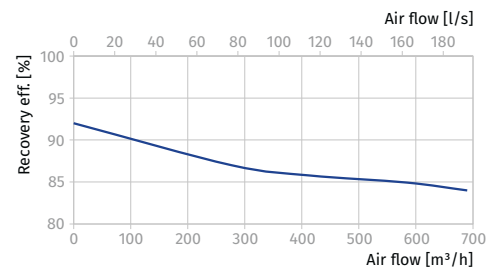



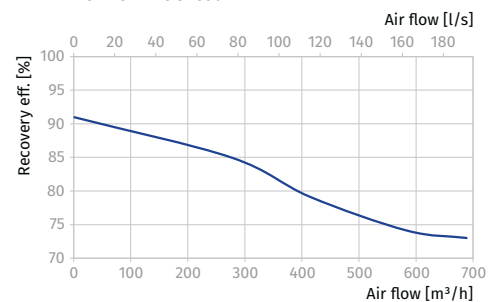













KOMFORT EC SB550











































KOMFORT EC SB550-E



Accessories

		KOMFORT EC S160(-E) S21	KOMFORT EC S160(-E) S14	KOMFORT EC SB160(-E) S21
G3 panel filter		–	–	–
G4 panel filter		FP 285x195x10 G4	FP 285x195x10 G4	FP 285x195x10 G4
F7 panel filter		FP 285x195x10 F7	FP 285x195x10 F7	FP 285x195x10 F7
Control panel		S22	–	S22
Wi-Fi control panel		S22 Wi-Fi	–	S22 Wi-Fi
LCD control panel		S25	–	S25
Internal humidity sensor		FS2	FS2	FS2
CO ₂ sensor with indication		CD-1	CD-1	CD-1
CO ₂ sensor		CD-2	CD-2	CD-2
Humidity sensor		HR-S	HR-S	HR-S
VOC sensor		DPWQ30600	–	DPWQ30600
CO ₂ sensor		DPWQ40200	–	DPWQ40200
Humidity sensor		DPWC11200	–	DPWC11200
Kitchen exhaust hood		DAH 251-13	DAH 251-13	DAH 251-13
Electric preheater		EVH 125	–	EVH 125
Electric reheater		ENH 125	–	ENH 125
Syphon kit (for the units without an enthalpy heat exchanger)		SFK 20x32	SFK 20x32	SFK 20x32
Air damper		VKA 125	VKA 125	VKA 125
Electric actuator		LF230	LF230	LF230
Summer block		SB C6 366/285	SB C6 366/285	–

		KOMFORT EC SB160(-E) S14	KOMFORT EC S200(-E) S14	KOMFORT EC SB200(-E) S14
G3 panel filter		–	FP 264x195x18 G3	FP 264x195x18 G3
G4 panel filter		FP 285x195x10 G4	–	–
F7 panel filter		FP 285x195x10 F7	–	–
Control panel		–	–	–
Wi-Fi control panel		–	–	–
LCD control panel		–	–	–
Internal humidity sensor		FS2	FS2	FS2
CO ₂ sensor with indication		CD-1	CD-1	CD-1
CO ₂ sensor		CD-2	CD-2	CD-2
Humidity sensor		HR-S	HR-S	HR-S
VOC sensor		–	–	–
CO ₂ sensor		–	–	–
Humidity sensor		–	–	–
Kitchen exhaust hood		DAH 251-13	DAH 251-13	DAH 251-13
Electric preheater		–	–	–
Electric reheater		–	–	–
Syphon kit (for the units without an enthalpy heat exchanger)		SFK 20x32	SFK 20x32	SFK 20x32
Air damper		VKA 125	VKA 125	VKA 125
Electric actuator		LF230	LF230	LF230
Summer block		–	SB C6 366/240	–

		KOMFORT EC S250(-E) S14	KOMFORT EC SB250(-E) S21	KOMFORT EC SB250(-E) S14
G3 panel filter		–	–	–
G4 panel filter		FP 417x200x18 G4	FP 417x200x18 G4	FP 417x200x18 G4
F7 panel filter		FP 417x184x18 F7	FP 417x184x18 F7	FP 417x184x18 F7
Control panel		–	S22	–
Wi-Fi control panel		–	S22 Wi-Fi	–
LCD control panel		–	S25	–
Internal humidity sensor		FS2	FS2	FS2
CO ₂ sensor with indication		CD-1	CD-1	CD-1
CO ₂ sensor		CD-2	CD-2	CD-2
Humidity sensor		HR-S	HR-S	HR-S
VOC sensor		–	DPWQ30600	–
CO ₂ sensor		–	DPWQ40200	–
Humidity sensor		–	DPWC11200	–
Kitchen exhaust hood		DAH 251-13	DAH 251-13	DAH 251-13
Electric preheater		–	EVH 160	–
Electric reheater		–	ENH 160	–
Syphon kit (for the units without an enthalpy heat exchanger)		SFK 20x32	SFK 20x32	SFK 20x32
Air damper		VKA 160	VKA 160	VKA 160
Electric actuator		LF230	LF230	LF230
Summer block		SB C6 366/384	–	–

		KOMFORT EC SB350(-E) S21	KOMFORT EC SB350(-E) S14	KOMFORT EC SB550(-E) S21	KOMFORT EC SB550(-E) S14
G3 panel filter		–	–	–	–
G4 panel filter		FP 500x196x40 G4	FP 500x196x40 G4	FP 630x198x40 G4	FP 630x198x40 G4
F7 panel filter		FP 500x196x40 F7	FP 500x196x40 F7	FP 630x198x40 F7	FP 630x198x40 F7
Control panel		S22	–	S22	–
Wi-Fi control panel		S22 Wi-Fi	–	S22 Wi-Fi	–
LCD control panel		S25	–	S25	–
Internal humidity sensor		FS2	FS2	FS2	FS2
CO ₂ sensor with indication		CD-1	CD-1	CD-1	CD-1
CO ₂ sensor		CD-2	CD-2	CD-2	CD-2
Humidity sensor		HR-S	HR-S	HR-S	HR-S
VOC sensor		DPWQ30600	–	DPWQ30600	–
CO ₂ sensor		DPWQ40200	–	DPWQ40200	–
Humidity sensor		DPWC11200	–	DPWC11200	–
Kitchen exhaust hood		DAH 251-13	DAH 251-13	DAH 251-13	DAH 251-13
Electric preheater		EVH 160	–	EVH 200	–
Electric reheater		ENH 160	–	ENH 200	–
Syphon kit (for the units without an enthalpy heat exchanger)		SFK 20x32	SFK 20x32	SFK 20x32	SFK 20x32
Air damper		VKA 160	VKA 160	VKA 200	VKA 200
Electric actuator		LF230	LF230	LF230	LF230
Summer block		–	–	–	–